



深圳市勋瑞光电科技有限公司

Xunrui Shenzhen Optoelectronics Technology Co., Ltd.

MODEL NO:H0280H37-0005

CUSTOMER: _____

This module uses ROHS material

Customer Approval:

- Approve Specification Only**
- Approve Specification and Sample**

APPROVED
DATE:

ISSUED DATE: 2012-4-25

PREPARED	CHECKED LX	APPROVED LX



深圳市勋瑞光电科技有限公司

Xunrui Shenzhen Optoelectronics Technology Co., Ltd.

Contents

1	Introduction-----	4
2	General specification-----	5
3	Mechanical drawing-----	6
4	Absolute maximum ratings-----	7
5	Electrical characteristics-----	7
6	Touch Panel specifications -----	8
7	Optical characteristics -----	9
8	Pin Assignment -----	12
9	Block diagram -----	13
10	LCM quality criteria-----	14
11	Packing method-----	21



1. Introduction

1.1 Scope of application

This specification applies to the Negative type TFT transmissive dot matrix LCD module that is supplied XR OPTOELECTRONICS. This LCD module should be designed for mobile phone use.

LCD specification: Dots 240xRGBx320.

As to basic specification of the driver IC, refer to the IC (ILI9341) specification and datasheet.

1.2 Structure:

Double display structure:

TFT Module + FPC + Touch Panel +BL

FULL 65k or 262k Color 2.8 inch TFT LCD size for main LCD;

One bare chip with gold bump (COG) TECH;

16/8 BITS 80 parallel and RGB interface;

1.3 TFT features:

Structure: TFT PANNEL+IC+FPC+BL+TP;

Transmissive Type LCD

240 dot-source and 320 dot-gate outputs;

65k or 262k Color can be selected by software;

White LED back light;

16/8 BITS 80 parallel interface;

1.4 Applications:

Mobile phone

PSP

PDA

GPS

Etc...

2. General specification



深圳市勋瑞光电科技有限公司

Xunrui Shenzhen Optoelectronics Technology Co., Ltd.

ITEM	Standard value	UNIT
LCD Type	TFT Transmissive	---
Driver element	a-Si TFT Active matrix	
Number of Dots	240*(RGB)*320	Dots
Pixel Arrangement	RGB Vertical Stripe	
Active Area	43.20 *57.60	mm
Viewing Area (W*H)	/	mm
Viewing Direction	12 O'clock	
Driver IC	ILI9341	
Module Size(W*H*T)	50x67.2x2.5	mm
Approx. Weight	TBD	g
Back Light	White LED	
Touch Panel Type	4-wire Analog Resistive	
Touch Panel Active Area	49.6x68.8	mm
Touch Panel Type	4-wire Analog Resistive	
System interface	16/8 BITS 80 parallel interface	



3. Mechanical drawing

VER.	DESCRIPTION	DATE
#0	THE FIRST ISSUE	

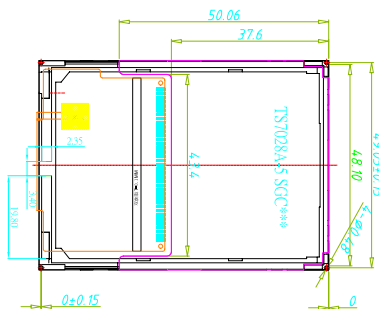
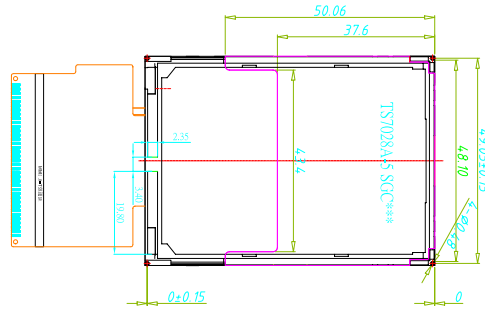
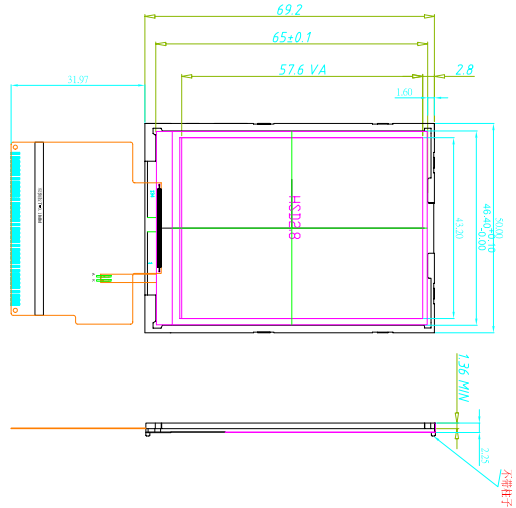

- NOTES:
- 1.DISPLAY TYPE: Main LCD:2.8" TFT, Transmissive
 2. OPERATING TEMP: -20°C~70°C
 3. STORAGE TEMP : -30°C~80°C
 4. MAIN LCD DRIVER: ILI9341
 5. BACKLIGHT: 4CHIP-WHITE LED
 - 6.UNSPECIFIED TOLERANCES:±0.2MM

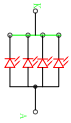

Backlight circuit
DC3.2V,1.5mA*4

No.	PTN NAME
1	D00
2	D01
3	D02
4	D03
5	GND
6	VDD
7	NCS
8	RS
9	/WR
10	/RD
11	1M0
12	NC
13	NC
14	NC
15	NC
16	LED A
17	LED K
18	LED K
19	LED K
20	LED K
21	LED ID
22	D04
23	D08
24	D09
25	D010
26	D011
27	D012
28	D013
29	D014
30	D015
31	/RESET
32	VCT
33	VDD
34	GND
35	D05
36	D06
37	D07

 <p>深圳市勋瑞光电科技有限公司 Xunrui Shenzhen Optoelectronics Technology Co., Ltd.</p>		SCALE : PTT	
成品型号		日期	2014.10.25
设计		日期	
结构审核		日期	
电子审核		日期	
		UNIT : mm	
		PRO.(3):	
		SHEET : 1/5	



4. ABSOLUTE MAXIMUM RATINGS

Parameter	Symbol	Min	Max	Unit
Supply voltage for logic	V_{CC}	-0.3	3.3	V
Input voltage for logic	V_{IN}	-0.5	$V_{CC} + 0.3$	V
Supply current (One LED)	I_{LED}		20	mA
Operating temperature	T_{OP}	-10	+60	°C
Storage temperature	T_{ST}	-20	+70	°C

5. ELECTRICAL CHARACTERISTICS

Item	Symbol	Min	Typ	Max	Unit	Applicable terminal
Supply voltage for logic	V_{CC}	2.5	2.8	3.3	V	V_{DD}
Input voltage	V_{IL}	-0.3	-	$0.2 V_{DD}$	V	
	V_{IH}	$0.8 V_{CC}$	-	V_{CC}	V	
Input leakage current	I_{LKG}				μA	
LED Forward voltage	V_f	3.0	3.2	3.4	V	--
Input backlight current	I_{LED}	-	15	20	mA	With One LED



深圳市勋瑞光电科技有限公司

Xunrui Shenzhen Optoelectronics Technology Co., Ltd.

Brightness		B	Viewing normal angle	170	200	--	Cd/m ²	All left side data are based on BOOYI's product reference only
Contrast Ratio		CR		150	250	--	--	
Response Time		Tr		--	10	20	ms	
		Tf		--	20	30	ms	
CIE Color coordinate	Red	XR	0.602	0.632	0.662			
		YR	0.298	0.328	0.358			
	Green	XG	0.266	0.296	0.326			
		YG	0.546	0.576	0.606			
	Blue	XB	0.103	0.133	0.163			
		YB	0.092	0.122	0.152			
White	XW	0.274	0.304	0.334				
	YW	0.304	0.334	0.364				
Viewing Angle	Hor.	θ_{x+}	Center CR>=10	--	45	--	Deg.	
		θ_{x-}		--	45	--		
	Ver.	θ_{y+}		--	35	--		
		θ_{y-}		--	15	--		
Uniformity	Un			80	85		%	

Note 1 : Definition of Viewing Angle θ_x and θ_y :

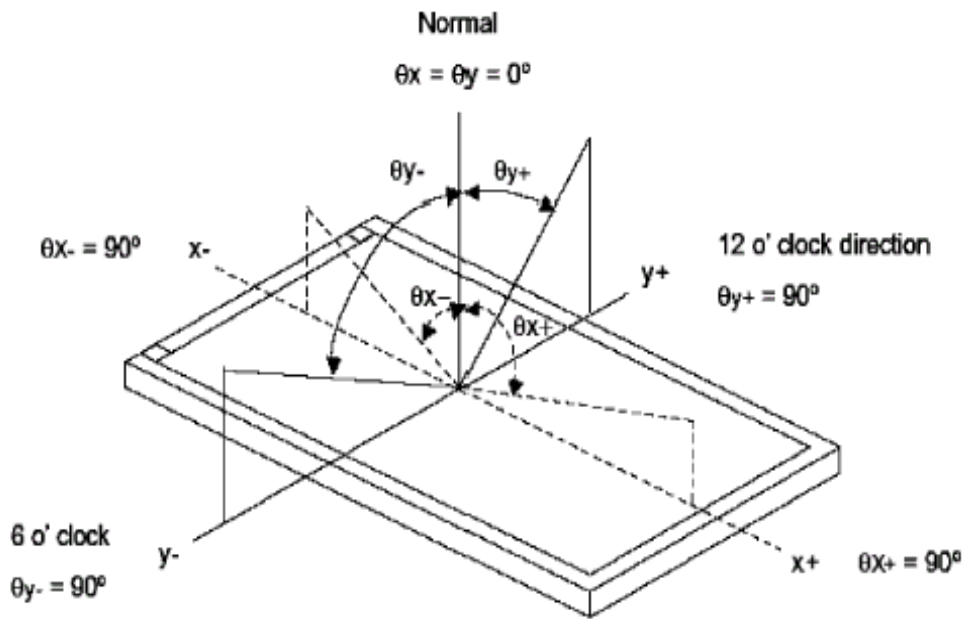

Note 2: Definition of contrast ratio CR:



$$CR = \frac{\text{Brightness of non-selected dots (white)}}{\text{Brightness of selected dots (black)}}$$

Note 3: Definition of response time (T_R , T_F)

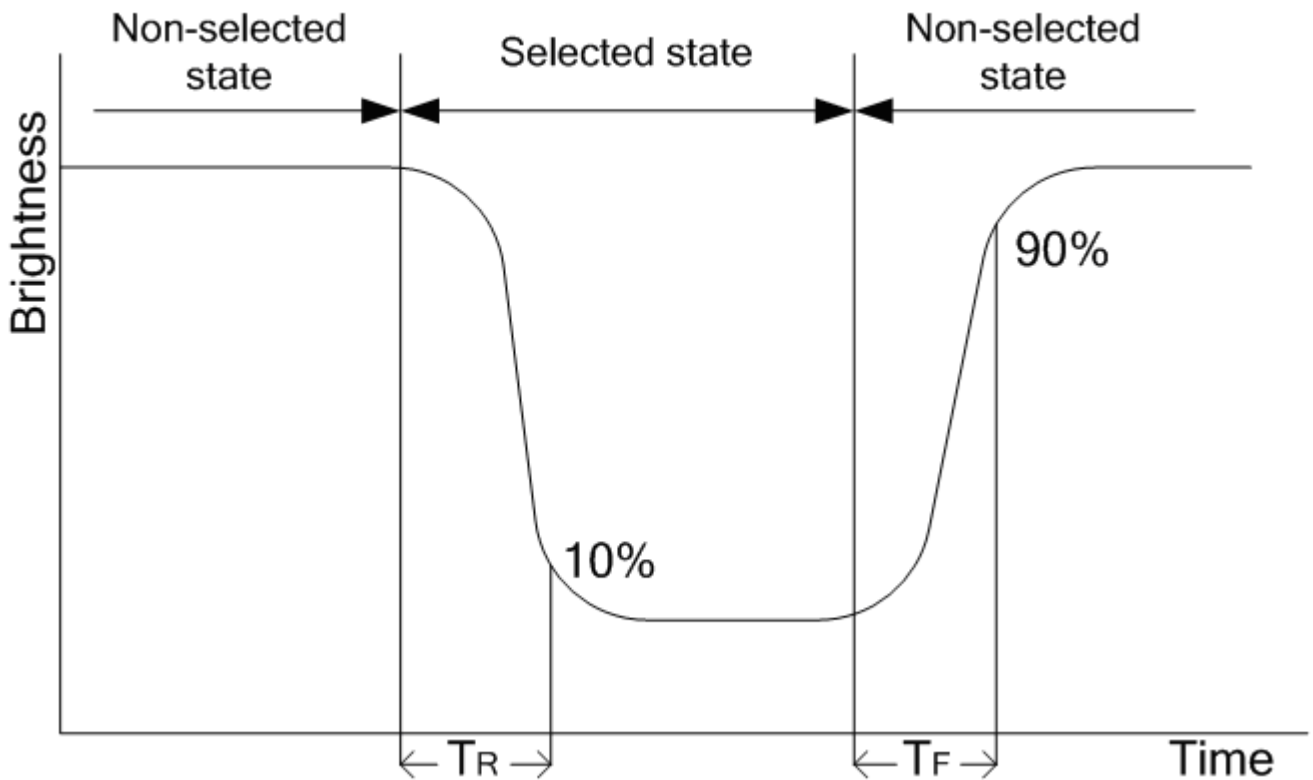



深圳市勋瑞光电科技有限公司

Xunrui Shenzhen Optoelectronics Technology Co., Ltd.

The brightness test equipment setup

20mA Field=2° (As measuring "black" image, field=2° is the best testing condition)

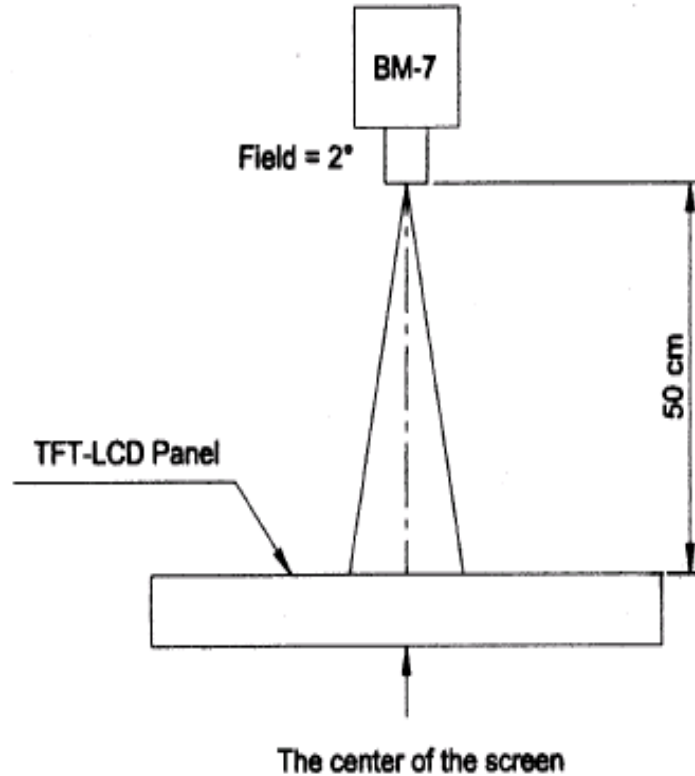

Note 4 :

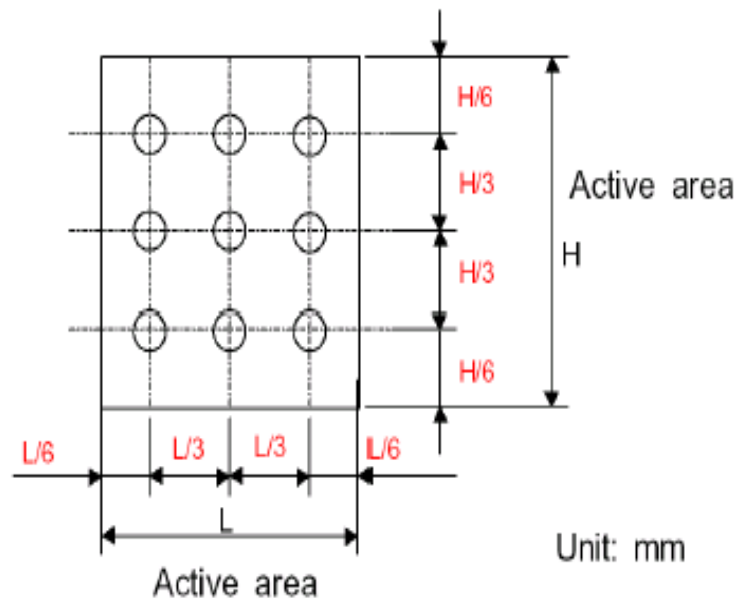



10. LCM Quality Criteria

10.1 VISUAL & FUNCTION INSPECTION STANDARD

10.1.1 Inspection conditions

Inspection performed under the following conditions is recommended.

Temperature : 25±5℃

Humidity : 65%±10%RH

Viewing Angle : Normal viewing Angle.

Illumination: Single fluorescent lamp (300 to 700Lux)

Viewing distance:30-50cm

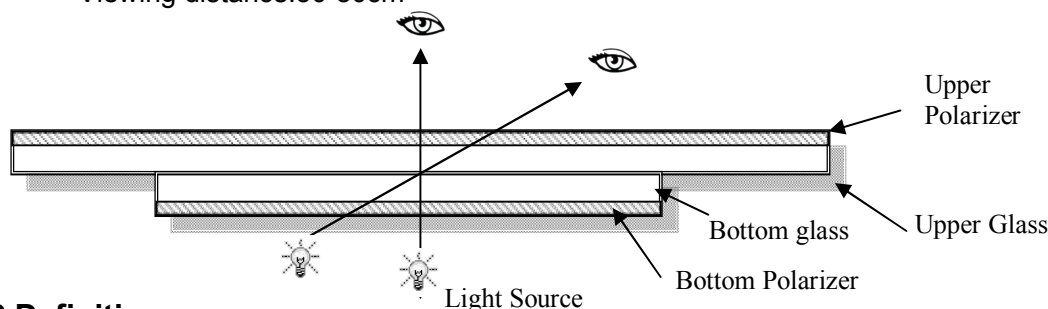

10.1.2 Definition

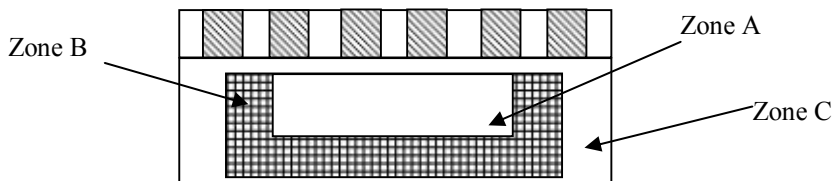

Zone A : Effective Viewing Area(Character or Digit can be seen)

Zone B : Viewing Area except Zone A

Zone C : Outside (Zone A+Zone B) which can not be seen after assembly by customer .)

Note:

As a general rule ,visual defects in Zone C can be ignored when it doesn't effect product function or appearance after assembly by customer.

10.1.3 Sampling Plan

According to GB/T 2828-2003 ; , normal inspection, Class II

AQL:

Major defect	Minor defect
0.65	1.5

LCD: Liquid Crystal Display , TP: Touch Panel , LCM: Liquid Crystal Module

No	Items to be inspected	Criteria	Classification of defects
1	Functional defects	1) No display, Open or miss line 2) Display abnormally, Short 3) Backlight no lighting, abnormal lighting. 4) TP no function	Major
2	Missing	Missing component	
3	Outline dimension	Overall outline dimension beyond the drawing is not allowed	
4	Color tone	Color unevenness, refer to limited sample	Minor



5	Soldering appearance	Good soldering , Peeling off is not allowed.	
6	LCD/Polarizer/TP	Black/White spot/line, scratch, crack, etc.	

10.1.4 Criteria (Visual)

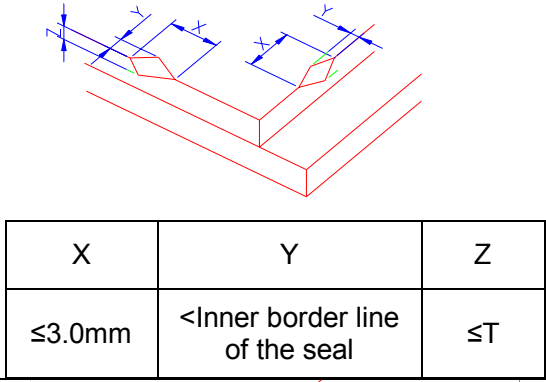
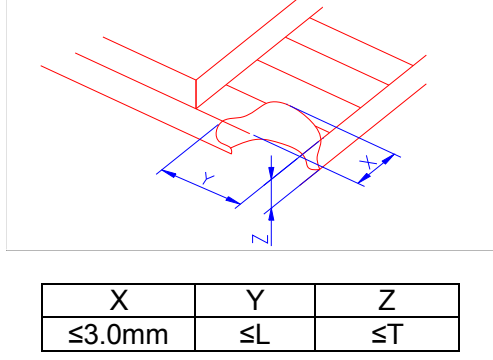
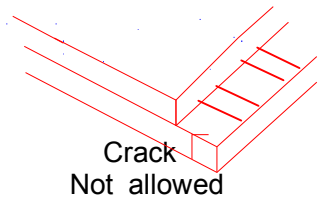
Number	Items	Criteria(mm)						
1.0 LCD Crack/Broken NOTE: X: Length Y: Width Z: Height L: Length of ITO, T: Height of LCD	(1) The edge of LCD broken	 <table border="1" data-bbox="853 698 1401 862"> <tr> <td>X</td> <td>Y</td> <td>Z</td> </tr> <tr> <td>≤3.0mm</td> <td><Inner border line of the seal</td> <td>≤T</td> </tr> </table>	X	Y	Z	≤3.0mm	<Inner border line of the seal	≤T
	X	Y	Z					
	≤3.0mm	<Inner border line of the seal	≤T					
(2)LCD corner broken	 <table border="1" data-bbox="912 1142 1337 1214"> <tr> <td>X</td> <td>Y</td> <td>Z</td> </tr> <tr> <td>≤3.0mm</td> <td>≤L</td> <td>≤T</td> </tr> </table>	X	Y	Z	≤3.0mm	≤L	≤T	
X	Y	Z						
≤3.0mm	≤L	≤T						
(3) LCD crack	 <p>Crack Not allowed</p>							



深圳市勋瑞光电科技有限公司

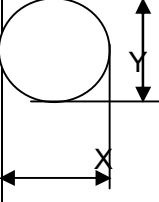

Xunrui Shenzhen Optoelectronics Technology Co., Ltd.

Number	Items	Criteria (mm)																										
2.0	Spot defect  $\Phi=(X+Y)/2$	① light dot (LCD/TP/Polarizer black/white spot , light dot, pinhole, dent, stain) <table border="1" data-bbox="443 347 1232 712"> <thead> <tr> <th rowspan="2">Zone Size (mm)</th> <th colspan="3">Acceptable Qty</th> </tr> <tr> <th>A</th> <th>B</th> <th>C</th> </tr> </thead> <tbody> <tr> <td>$\Phi \leq 0.10$</td> <td colspan="3">Ignore</td> </tr> <tr> <td>$0.10 < \Phi \leq 0.15$</td> <td colspan="3">3(distance $\geq 10\text{mm}$)</td> </tr> <tr> <td>$0.15 < \Phi \leq 0.2$</td> <td colspan="3">1</td> </tr> <tr> <td>$0.2 < \Phi$</td> <td colspan="3">0</td> </tr> </tbody> </table>	Zone Size (mm)	Acceptable Qty			A	B	C	$\Phi \leq 0.10$	Ignore			$0.10 < \Phi \leq 0.15$	3(distance $\geq 10\text{mm}$)			$0.15 < \Phi \leq 0.2$	1			$0.2 < \Phi$	0					
		Zone Size (mm)		Acceptable Qty																								
			A	B	C																							
		$\Phi \leq 0.10$	Ignore																									
		$0.10 < \Phi \leq 0.15$	3(distance $\geq 10\text{mm}$)																									
		$0.15 < \Phi \leq 0.2$	1																									
		$0.2 < \Phi$	0																									
		② Dim spot (LCD/TP/Polarizer dim dot, light leakage、dark spot) <table border="1" data-bbox="443 779 1232 1144"> <thead> <tr> <th rowspan="2">Zone Size (mm)</th> <th colspan="3">Acceptable Qty</th> </tr> <tr> <th>A</th> <th>B</th> <th>C</th> </tr> </thead> <tbody> <tr> <td>$\Phi \leq 0.1$</td> <td colspan="3">Ignore</td> </tr> <tr> <td>$0.1 < \Phi \leq 0.2$</td> <td colspan="3">2(distance $\geq 10\text{mm}$)</td> </tr> <tr> <td>$0.2 < \Phi \leq 0.3$</td> <td colspan="3">1</td> </tr> <tr> <td>$\Phi > 0.3$</td> <td colspan="3">0</td> </tr> </tbody> </table>	Zone Size (mm)	Acceptable Qty			A	B	C	$\Phi \leq 0.1$	Ignore			$0.1 < \Phi \leq 0.2$	2(distance $\geq 10\text{mm}$)			$0.2 < \Phi \leq 0.3$	1			$\Phi > 0.3$	0					
		Zone Size (mm)		Acceptable Qty																								
			A	B	C																							
		$\Phi \leq 0.1$	Ignore																									
		$0.1 < \Phi \leq 0.2$	2(distance $\geq 10\text{mm}$)																									
$0.2 < \Phi \leq 0.3$	1																											
$\Phi > 0.3$	0																											
③ Polarizer accidented spot <table border="1" data-bbox="443 1211 1232 1509"> <thead> <tr> <th rowspan="2">Zone Size (mm)</th> <th colspan="3">Acceptable Qty</th> </tr> <tr> <th>A</th> <th>B</th> <th>C</th> </tr> </thead> <tbody> <tr> <td>$\Phi \leq 0.2$</td> <td colspan="3">Ignore</td> </tr> <tr> <td>$0.2 < \Phi \leq 0.5$</td> <td colspan="3">2(distance $\geq 10\text{mm}$)</td> </tr> <tr> <td>$\Phi > 0.5$</td> <td colspan="3">0</td> </tr> </tbody> </table>	Zone Size (mm)	Acceptable Qty			A	B	C	$\Phi \leq 0.2$	Ignore			$0.2 < \Phi \leq 0.5$	2(distance $\geq 10\text{mm}$)			$\Phi > 0.5$	0											
Zone Size (mm)		Acceptable Qty																										
	A	B	C																									
$\Phi \leq 0.2$	Ignore																											
$0.2 < \Phi \leq 0.5$	2(distance $\geq 10\text{mm}$)																											
$\Phi > 0.5$	0																											
Line defect (LCD/TP /Polarizer black/white line, scratch, stain)	<table border="1" data-bbox="443 1547 1232 1912"> <thead> <tr> <th rowspan="2">Width(mm)</th> <th rowspan="2">Length(mm)</th> <th colspan="3">Acceptable Qty</th> </tr> <tr> <th>A</th> <th>B</th> <th>C</th> </tr> </thead> <tbody> <tr> <td>$\Phi \leq 0.03$</td> <td>Ignore</td> <td colspan="3">Ignore</td> </tr> <tr> <td>$0.03 < W \leq 0.05$</td> <td>$L \leq 3.0$</td> <td colspan="2">$N \leq 2$</td> <td rowspan="2">Ignore</td> </tr> <tr> <td>$0.05 < W \leq 0.08$</td> <td>$L \leq 2.0$</td> <td colspan="2">$N \leq 2$</td> </tr> <tr> <td>$0.08 < W$</td> <td colspan="4">Define as spot defect</td> </tr> </tbody> </table>	Width(mm)	Length(mm)	Acceptable Qty			A	B	C	$\Phi \leq 0.03$	Ignore	Ignore			$0.03 < W \leq 0.05$	$L \leq 3.0$	$N \leq 2$		Ignore	$0.05 < W \leq 0.08$	$L \leq 2.0$	$N \leq 2$		$0.08 < W$	Define as spot defect			
Width(mm)	Length(mm)			Acceptable Qty																								
		A	B	C																								
$\Phi \leq 0.03$	Ignore	Ignore																										
$0.03 < W \leq 0.05$	$L \leq 3.0$	$N \leq 2$		Ignore																								
$0.05 < W \leq 0.08$	$L \leq 2.0$	$N \leq 2$																										
$0.08 < W$	Define as spot defect																											

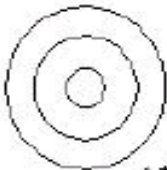

深圳市勋瑞光电科技有限公司

Xunrui Shenzhen Optoelectronics Technology Co., Ltd.

3.0	Polarizer Bubble	<table border="1"> <thead> <tr> <th rowspan="2">Zone Size (mm)</th> <th colspan="3">Acceptable Qty</th> </tr> <tr> <th>A</th> <th>B</th> <th>C</th> </tr> </thead> <tbody> <tr> <td>$\Phi \leq 0.2$</td> <td colspan="3">Ignore</td> </tr> <tr> <td>$0.2 < \Phi \leq 0.4$</td> <td colspan="3">2 (distance $\geq 10\text{mm}$)</td> </tr> <tr> <td>$0.4 < \Phi \leq 0.6$</td> <td colspan="3">1</td> </tr> <tr> <td>$0.6 < \Phi$</td> <td colspan="3">0</td> </tr> </tbody> </table>			Zone Size (mm)	Acceptable Qty			A	B	C	$\Phi \leq 0.2$	Ignore			$0.2 < \Phi \leq 0.4$	2 (distance $\geq 10\text{mm}$)			$0.4 < \Phi \leq 0.6$	1			$0.6 < \Phi$	0			
		Zone Size (mm)	Acceptable Qty																									
			A	B	C																							
		$\Phi \leq 0.2$	Ignore																									
		$0.2 < \Phi \leq 0.4$	2 (distance $\geq 10\text{mm}$)																									
$0.4 < \Phi \leq 0.6$	1																											
$0.6 < \Phi$	0																											
4.0	SMT	According to IPC-A-610C class II standard . Function defect and missing part are major defect ,the others are minor defect.																										
5.0	TP Related	TP bubble/ accidented spot	<table border="1"> <thead> <tr> <th rowspan="2">Size Φ(mm)</th> <th colspan="3">Acceptable Qty</th> </tr> <tr> <th>A</th> <th>B</th> <th>C</th> </tr> </thead> <tbody> <tr> <td>$\Phi \leq 0.1$</td> <td colspan="3">Ignore</td> </tr> <tr> <td>$0.1 < \Phi \leq 0.2$</td> <td colspan="3">2</td> </tr> <tr> <td>$0.2 < \Phi \leq 0.3$</td> <td colspan="3">1</td> </tr> <tr> <td>$0.3 < \Phi$</td> <td colspan="3">0</td> </tr> </tbody> </table>			Size Φ (mm)	Acceptable Qty			A	B	C	$\Phi \leq 0.1$	Ignore			$0.1 < \Phi \leq 0.2$	2			$0.2 < \Phi \leq 0.3$	1			$0.3 < \Phi$	0		
			Size Φ (mm)	Acceptable Qty																								
				A	B	C																						
			$\Phi \leq 0.1$	Ignore																								
$0.1 < \Phi \leq 0.2$	2																											
$0.2 < \Phi \leq 0.3$	1																											
$0.3 < \Phi$	0																											
Assembly deflection	beyond the edge of backlight $\leq 0.15\text{mm}$																											
Newton Ring	<p>Newton Ring area $> 1/3$ TP area NG</p> <p>Newton Ring area $\leq 1/3$ TP area OK</p>	 <p>1 规律性</p>  <p>2 非规律性</p>  <p>似牛顿环</p>																										



深圳市勋瑞光电科技有限公司

Xunrui Shenzhen Optoelectronics Technology Co., Ltd.

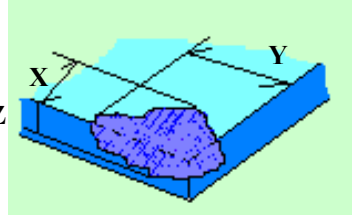
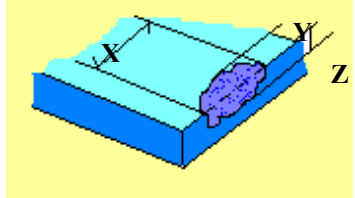
	TP corner broken X: length Y: width Z: height	<table border="1"> <tr> <td>X</td> <td>Y</td> <td>Z</td> </tr> <tr> <td>$X \leq 3.0\text{mm}$</td> <td>$Y \leq 3.0\text{mm}$</td> <td>$Z < \text{LCD thickness}$</td> </tr> </table> <p>* Circuitry broken is not allowed.</p>	X	Y	Z	$X \leq 3.0\text{mm}$	$Y \leq 3.0\text{mm}$	$Z < \text{LCD thickness}$	
	X	Y	Z						
$X \leq 3.0\text{mm}$	$Y \leq 3.0\text{mm}$	$Z < \text{LCD thickness}$							
TP edge broken X: length Y: width Z: height	<table border="1"> <tr> <td>X</td> <td>Y</td> <td>Z</td> </tr> <tr> <td>$X \leq 6.0\text{mm}$</td> <td>$Y \leq 2.0\text{mm}$</td> <td>$Z < \text{LCD thickness}$</td> </tr> </table> <p>* Circuitry broken is not allowed.</p>	X	Y	Z	$X \leq 6.0\text{mm}$	$Y \leq 2.0\text{mm}$	$Z < \text{LCD thickness}$		
X	Y	Z							
$X \leq 6.0\text{mm}$	$Y \leq 2.0\text{mm}$	$Z < \text{LCD thickness}$							

Criteria (functional items)

Number	Items	Criteria (mm)
1	No display	Not allowed
2	Missing segment	Not allowed
3	Short	Not allowed
4	Backlight no lighting	Not allowed
5	TP no function	Not allowed

10.2 RELIABILITY TEST

NO	ITEM	CONDITION	STANDARD
1	High Temp. Storage	70°C, 12 hours	1. Functional test is OK. Missing Segment, short, unclear segment, non-display, display abnormally and liquid crystal leak are un-allowed.
2	Low Temp. Storage	-20°C, 12 hours	
3	High Temp. Operation	60°C, 12 hours	
4	Low Temp. Operation	-10°C, 12 hours	
5	High temperature and high Humidity storage	40°C, 90%RH, 12 hours	2. No low temperature bubbles, end seal loose and fall, frame rainbow.
6	Thermal and cold shock	Static state, -20°C (30 Min) ~70°C (30 Min) ~ -20°C (30Min), packaging, 10 cycles	1. Function test is OK. 2. No glass crack, chipped glass, end seal loose and fall, epoxy frame crack and so on. 3. No structure loose and fall.
7	Vibration test	Packaging, Frequency : 10-55Hz Amplitude : 1.0mm, Each direction on X,Y axe 0.5 heure, circle 2 hours	
8	Dropping test	Pack products into the carton box. Drop it from 80cm height to ground. Once for each side of the carton	

NOTE:

10.2.1 The reliability items will be fully performed in new sample qualification,

10.2.2 The reliability status will be tested as monitor during mass production. Individual reliability test shall be



performed by lot , Moreover, the individual reliability item shall be decided according to reliability plan.

10.2.3 All samples are inspected after keeping in the room with normal temperature and humidity for 2 hours or above.

10.2.4 Vibration test: It is not necessary to test for those products without assembly frame , back light ,PCB and so on.

10.2.5 Dropping test : It is necessary for affirming new package.

10.2.6 For the high temperature and high humidity test, pure water of over 10 MΩ.cm should be used.

10.2.7 Each test item applies for test LCM only once .Then tested LCM cannot be used again in any other test item.

10.2.8 The quantity of LCM examination for each test item is 5pcs to 10pcs.

10.3 Safety instructions

10.3.1 If the LCD panel breaks, be careful not to get any liquid crystal substance in your mouth.

10.3.2 If the liquid crystal substance touches your skin or clothes, please wash it off immediately by using soap and water.

10.4 Handling Precautions

10.4.1 Avoid static electricity damaging the LSI.

10.4.2 Do not remove the panel or frame from the module .

10.4.3 The polarizing plate of the display is very fragile . So, please handle it very carefully.

10.4.4 Do not wipe the polarizing plate with a dry cloth, as it may easily scratch the surface of the plate.

10.4.5 The color tone of display and background of LCM has the possibility to be changed in the storage temperature range.

10.4.6 Pay attention to the working environment, as the element may be destroyed by static electricity.

--Be sure to ground human body and electric appliance during work.

--Avoid working in a dry environment to minimize the generations of static electricity.

--Static electricity may be generated when the protective film is fast peeled off.

10.4.7 When soldering the terminal of LCM, make certain the AC power source of soldering iron does not leak.

10.4.8 If the display surface becomes contaminated ,breathe on the surface and gently wipe it with a soft-dry- clean cloth .If it is heavily contaminated ,moisten cloth with the following solvent(ex:Ethyl alcohol).Solvents other than those above-mentioned may damage the polarizer(Especially ,do not use them .ex: Water / Ketone)

10.5 Operation instructions

10.5.1 It is recommended to drive the LCD within the specified voltage limits, try to adjust the operating voltage for the optimal contrast, the color and contrast of LCD panel will varies at different temperature.

10.5.2 Response time is greatly delayed at low operating temperature range. However, this does not mean the LCD will be out of the order, It will recover when it returns to the specified temperature range.

10.5.3 If the display area is pushed hard during operation, the display will become abnormal.

10.5.4 Do not operate the LCD at the environments over the specified conditions, this may cause damage on the LCD and shorten the lifetime.

10.6 Storage instructions:

10.6.1 Store LCDs in a sealed polyethylene bag.

10.6.2 Store LCDs in a dark place, Do not expose to sunlight or fluorescent light. Keep the temperature between 0°C and 35°C.

10.6.3 Avoid the polarizer touch any other object, (It is recommended to store them in the container in which they were shipped.)

10.7 Limited Warranty



- 10.7.1 will replace or repair any of its LCD modules, which are found to be defective, when inspected in accordance with LCM acceptance standards (copies available upon request) for a period of 12 months from ink- print date on product
- 10.7.2 Any defects must be returned to within 60 days since ship-out. Confirmation of such date shall be based on freight documents. The warranty liability of wasam limited to repair and/or replacement on defects above (7.1,7.2)
- 10.7.3 No warranty can be granted if the precautions stated above have been disregarded. The typical samples are as below:
- LCD glass crack/break
 - PCB outlet is damaged or modified.
 - PCB conductors damaged.
 - Circuit modified with by grinding, engraving or painting varnish.
 - FPC crack
- 10.7.4 Modules must be returned with sufficient description of the failures of defects. Any connectors or cable installed by the customer must be removed completely without damaging the PCB outlet, conductors and terminals. Modules must be packed with the container in which they were shipped.

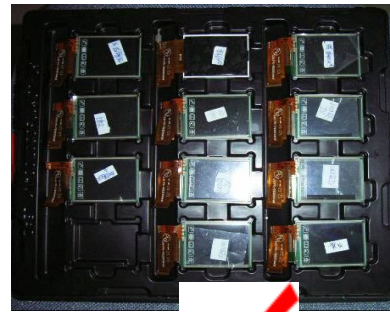
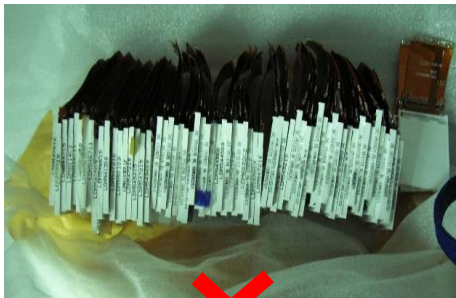

11. Packing method

-----TBD